



UNI-HYDRO™

2021 PUNCHES & DIES AND TOOLING CATALOG

MADE IN THE USA SINCE 1974

EST.



1974

Our years of engineering experience delivers longer tooling life for your benefit.

- Chuck Dvorak

TABLE OF CONTENTS

2. Punch & Die Order Form
3. L 100 Series Punches
7. L 150 Series Punches
10. 500 Series Punches
11. S-Series Round Punches
12. Unique Punches
13. Specialty Order Punches
14. Ironworker Tooling
15. Universal Sever Housing
16. Sever Blades
18. Slug Type Angle Shear
19. 2-Part Brake
20. Spring Return Brake
21. V-Coper Notcher
22. Square Notcher
23. Pipe Notcher
24. Accessories
25. Printable Tonnage Chart

We're punching while they're rusting!

EST.

1974



PUNCH & DIE ORDER REQUEST FORM

BILLING INFO

SHIPPING INFO

PURCHASE ORDER #

Bill to your own UPS account? Add # below.

QTY	PART NUMBER	SERIES	SHAPE	SIZE (EX: 3/4" X 1")	NOTES

Prices subject to change without notice. All prices are F.O.B. Cosmos, Minnesota. We reserve the right to make changes in design and specifications without notice. Orders under \$50.00 are subject to a minimum \$5.00 service charge.



L 100 SERIES ROUND

UNI-HYDRO PUNCHES & DIES

L 100 Round

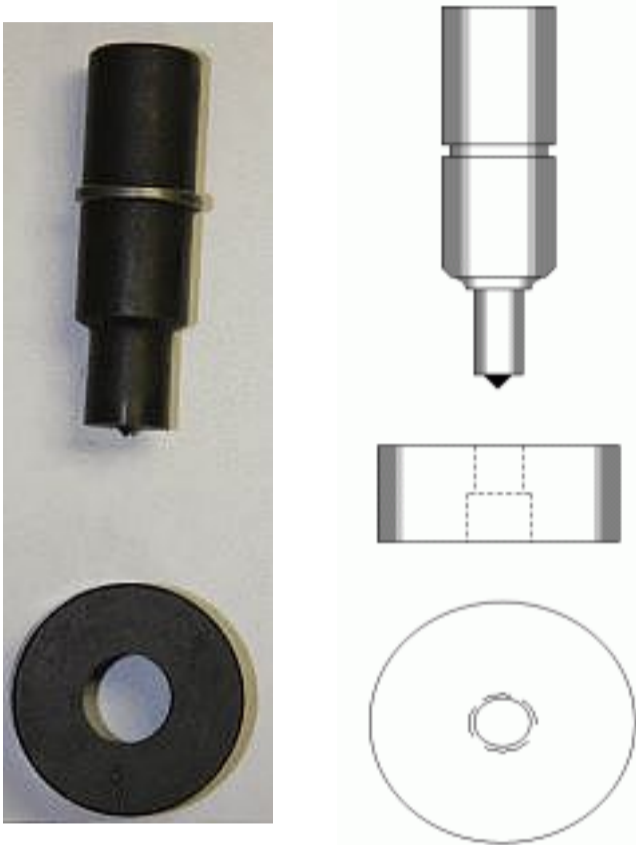

SIZE	PUNCH	DIE
1/8	8101	6101
9/64	8102	6102
5/32	8103	6103
11/64	8104	6104
3/16	8105	6105
13/64	8106	6106
7/32	8107	6107
15/64	8108	6108
1/4	8109	6109
17/64	8110	6110
9/32	8111	6111
19/64	8112	6112
5/16	8113	6113
21/64	8114	6114
11/32	8115	6115
23/64	8116	6116
3/8	8117	6117
25/64	8118	6118
13/32	8119	6119
27/64	8120	6120
7/16	8121	6121
29/64	8122	6122
15/32	8123	6123
31/64	8124	6124
1/2	8125	6125
33/64	8126	6126
17/32	8127	6127
35/64	8128	6128
9/16	8129	6129
37/64	8130	6130
19/32	8131	6131
39/64	8132	6132
5/8	8133	6133
41/64	8134	6134
21/32	8135	6135
43/64	8136	6136
11/16	8137	6137
45/64	8138	6138
23/32	8139	6139
47/64	8140	6140
3/4	8141	6141
49/64	8142	6142
25/32	8143	6143
51/64	8144	6144
13/16	8145	6145

L 100 Round

SIZE	PUNCH	DIE
53/64	8146	6146
27/32	8147	6147
55/64	8148	6148
7/8	8149	6149
57/64	8150	6150
29/32	8151	6151
59/64	8152	6152
15/16	8153	6153
61/64	8154	6154
31/32	8155	6155
63/64	8156	6156
1"	8157	6157
1 1/64	8158	6158
1 1/32	8159	6159
1 3/64	8160	6160
1 1/16	8161	6161
1 5/64	8162	6162
1 3/32	8163	6163
1 7/64	8164	6164
1 1/8	8165	6165
1 9/64	8166	6166
1 5/32	8167	6167
1 11/64	8168	6168
1 3/16	8169	6169
1 13/64	8170	6170
1 7/32	8171	6171
1 15/64	8172	6172
1 1/4	8173	6173
1 17/64	8174	6174
1 9/32	8175	6175
1 19/64	8176	6176
1 5/16	8177	6177
1 21/64	8178	6178
1 11/32	8179	6179
1 23/64	8180	6180
1 3/8	8181	6181
1 13/32	8182	6182
1 7/16	8183	6183
1 15/32	8184	6184
1 1/2	8185	6185
1 17/32	8186	6186
1 9/16	8187	6187
1 19/32	8188	6188
1 5/8	8189	6189





L 100 SERIES HEXAGON

UNI-HYDRO PUNCHES & DIES

L 100 Hexagon



SIZE	PUNCH	DIE
1/4	8201	6201
17/64	8202	6202
9/32	8203	6203
19/64	8204	6204
5/16	8205	6205
21/64	8206	6206
11/32	8207	6207
23/64	8208	6208
3/8	8209	6209
25/64	8210	6210
13/32	8211	6211
27/64	8212	6212
7/16	8213	6213
29/64	8214	6214
15/32	8215	6215
31/64	8216	6216
1/2	8217	6217
33/64	8218	6218
17/32	8219	6219
35/64	8220	6220
9/16	8221	6221
37/64	8222	6222
19/32	8223	6223
39/64	8224	6224
5/8	8225	6225
41/64	8226	6226
21/32	8227	6227

L 100 Hexagon

SIZE	PUNCH	DIE
43/64	8228	6228
11/16	8229	6229
45/64	8230	6230
23/32	8231	6231
47/64	8232	6232
3/4	8233	6233
49/64	8234	6234
25/32	8235	6235
51/64	8236	6236
13/16	8237	6237
53/64	8238	6238
27/32	8239	6239
55/64	8240	6240
7/8	8241	6241
57/64	8242	6242
29/32	8243	6243
59/64	8244	6244
15/16	8245	6245
61/64	8246	6246
31/32	8247	6247
63/64	8248	6248
1"	8249	6249
1 1/64	8250	6250
1 1/32	8251	6251
1 3/64	8252	6252
1 1/16	8253	6253
1 1/8	8254	6254





L 100 SERIES SQUARE & RECTANGLE

UNI-HYDRO PUNCHES & DIES

L 100 Square



SIZE	PUNCH	DIE
7/32	8301	6301
1/4	8302	6302
9/32	8303	6303
5/16	8304	6304
11/32	8305	6305
3/8	8306	6306
13/32	8307	6307
7/16	8308	6308
15/32	8309	6309
1/2	8310	6310
17/32	8311	6311
9/16	8312	6312
19/32	8313	6313
5/8	8314	6314
21/32	8315	6315
11/16	8316	6316
23/32	8317	6317
3/4	8318	6318
25/32	8319	6319
13/16	8320	6320
27/32	8321	6321
7/8	8322	6322
29/32	8323	6323
15/16	8324	6324
31/32	8325	6325
1"	8326	6326
1 1/32	8327	6327
1 1/16	8328	6328

L 100 Rectangle



SIZE	PUNCH	DIE
3/4 X 1/4	8351	6351
3/4 X 9/32	8352	6352
3/4 X 5/16	8353	6353
3/4 X 11/32	8354	6354
3/4 X 3/8	8355	6355
3/4 X 13/32	8356	6356
3/4 X 7/16	8357	6357
3/4 X 15/32	8358	6358
3/4 X 1/2	8359	6359
3/4 X 17/32	8360	6360
3/4 X 9/16	8361	6361
3/4 X 19/32	8362	6362
3/4 X 5/8	8363	6363
3/4 X 21/32	8364	6364
3/4 X 11/16	8365	6365
3/4 X 23/32	8366	6366
1 X 1/4	8367	6367
1 X 9/32	8368	6368
1 X 5/16	8369	6369
1 X 11/32	8370	6370
1 X 3/8	8371	6371
1 X 13/32	8372	6372
1 X 7/16	8373	6373
1 X 15/32	8374	6374
1 X 3/8	8371	6371
1 X 1/2	8375	6375
1 X 17/32	8376	6376
1 X 9/16	8377	6377
1 X 19/32	8378	6378
1 X 5/8	8379	6379
1 X 21/32	8380	6380
1 X 11/16	8381	6381
1 X 23/32	8382	6382
1 X 3/4	8383	6383
1 X 25/32	8384	6384





L 100 SERIES OVAL

UNI-HYDRO PUNCHES & DIES

L 100 Oval

L 100 Oval

L 100 Oval

PUNCH	SIZE	DIE
1/2 X 1/8	8401	6401
1/2 X 5/32	8402	6402
1/2 X 3/16	8403	6403
1/2 X 7/32	8404	6404
1/2 X 1/4	8405	6405
1/2 X 9/32	8406	6406
1/2 X 5/16	8407	6407
1/2 X 11/32	8408	6408
1/2 X 3/8	8409	6409
1/2 X 13/32	8410	6410
1/2 X 7/16	8411	6411
1/2 X 15/32	8412	6412
5/8 X 1/8	8413	6413
5/8 X 5/32	8414	6414
5/8 X 3/16	8415	6415
5/8 X 7/32	8416	6416
5/8 X 1/4	8417	6417
5/8 X 9/32	8418	6418
5/8 X 5/16	8419	6419
5/8 X 11/32	8420	6420
5/8 X 3/8	8421	6421
5/8 X 13/32	8422	6422
5/8 X 7/16	8423	6423
5/8 X 15/32	8424	6424
5/8 X 1/2	8425	6425
5/8 X 17/32	8426	6426
5/8 X 9/16	8427	6427
5/8 X 19/32	8428	6428
3/4 X 1/8	8429	6429
3/4 X 5/32	8430	6430
3/4 X 3/16	8431	6431
3/4 X 7/32	8432	6432
3/4 X 1/4	8433	6433
3/4 X 9/32	8434	6434
3/4 X 5/16	8435	6435
3/4 X 11/32	8436	6436
3/4 X 3/8	8437	6437
3/4 X 13/32	8438	6438
3/4 X 7/16	8439	6439
3/4 X 15/32	8440	6440
3/4 X 1/2	8441	6441
3/4 X 17/32	8442	6442
3/4 X 9/16	8443	6443
3/4 X 19/32	8444	6444

PUNCH	SIZE	DIE
3/4 X 5/8	8445	6445
3/4 X 21/32	8446	6446
3/4 X 11/16	8447	6447
3/4 X 23/32	8448	6448
1 X 1/8	8449	6449
1 X 5/32	8450	6450
1 X 3/16	8451	6451
1 X 7/32	8452	6452
1 X 1/4	8453	6453
1 X 9/32	8454	6454
1 X 5/16	8455	6455
1 X 11/32	8456	6456
1 X 3/8	8457	6457
1 X 13/32	8458	6458
1 X 7/16	8459	6459
1 X 15/32	8460	6460
1 X 1/2	8461	6461
1 X 17/32	8462	6462
1 X 9/16	8463	6463
1 X 19/32	8464	6464
1 X 5/8	8465	6465
1 X 21/32	8466	6466
1 X 11/16	8467	6467
1 X 23/32	8468	6468
1 X 3/4	8469	6469
1 X 25/32	8470	6470
1 X 13/16	8471	6471
1 X 27/32	8472	6472
1 X 7/8	8473	6473
1 X 29/32	8474	6474
1 X 15/16	8475	6475
1 X 31/32	8476	6476
1-1/4 X 1/8	8477	6477
5/8	8478	6478
3/16	8479	6479
7/32	8480	6480
1-1/4 X 1/4	8481	6481
9/32	8482	6482
5/16	8483	6483
11/32	8484	6484
1-1/4 X 3/8	8485	6485
13/32	8486	6486
7/16	8487	6487
15/32	8488	6488
1-1/4 X 1/2	8489	6489

PUNCH	SIZE	DIE
1-1/4 X 17/32	8490	6490
1-1/4 X 9/16	8491	6491
1-1/4 X 19/32	8492	6492
1-1/4 X 5/8	8493	6493
1-1/4 X 21/32	8494	6494
1-1/4 X 11/16	8495	6495
1-1/4 X 23/32	8496	6496
1-1/4 X 3/4	8497	6497
1-1/4 X 25/32	8498	6498
1-1/4 X 13/16	8499	6499
1-1/4 X 27/32	8500	6500
1-1/4 X 7/8	8501	6501
1-1/4 X 29/32	8502	6502
1-1/4 X 15/16	8503	6503
1-1/4 X 31/32	8504	6504
1-1/4 X 1	8505	6505
1-1/4 X 1-1/32	8506	6506
1-1/4 X 1-1/16	8507	6507
1-1/4 X 1-3/32	8508	6508
1-1/4 X 1-1/8	8509	6509
1-1/4 X 1-5/32	8510	6510
1-1/4 X 1-3/16	8511	6511
1-1/4 X 1-7/32	8512	6512
1-1/2 X 1/4	8513	6513
1-1/2 X 5/16	8514	6514
1-1/2 X 3/8	8515	6515
1-1/2 X 13/32	8516	6516
1-1/2 X 7/16	8517	6517
1-1/2 X 15/32	8518	6518
1-1/2 X 1/2	8519	6519
1-1/2 X 17/32	8520	6520
1-1/2 X 9/16	8521	6521
1-1/2 X 19/32	8522	6522
1-1/2 X 5/8	8523	6523
1-1/2 X 21/32	8524	6524
1-1/2 X 11/16	8525	6525
1-1/2 X 23/32	8526	6526
1-1/2 X 3/4	8527	6527
1-1/2 X 25/32	8528	6528
1-1/2 X 13/16	8529	6529
1-1/2 X 27/32	8530	6530
1-1/2 X 7/8	8531	6531
1-1/2 X 29/32	8532	6532
1-1/2 X 15/16	8533	6533
1-1/2 X 1	653	653





L 150 SERIES ROUND - HEX

UNI-HYDRO PUNCHES & DIES

L 150 Round



SIZE	PUNCH	DIE
5/8	8551	6551
21/32	8552	6552
11/16	8553	6553
23/32	8554	6554
3/4	8555	6555
25/32	8556	6556
13/16	8557	6557
27/32	8558	6558
7/8	8559	6559
29/32	8560	6560
15/16	8561	6561
31/32	8562	6562
1"	8563	6563
1-1/32	8564	6564
1-1/16	8565	6565
1-3/32	8566	6566
1-1/8	8567	6567
1-5/32	8568	6568
1-3/16	8569	6569
1-7/32	8570	6570
1-1/4	8571	6571
1-9/32	8572	6572
1-5/16	8573	6573
1-11/32	8574	6574
1-3/8	8575	6575
1-13/32	8576	6576
1-7/16	8577	6577
1-15/32	8578	6578
1-1/2	8579	6579

L 150 Hexagon

SIZE	PUNCH	DIE
5/8	8601	6601
21/32	8602	6602
11/16	8603	6603
23/32	8604	6604
3/4	8605	6605
25/32	8606	6606
13/16	8607	6607
27/32	8608	6608
7/8	8609	6609
29/32	8610	6610
15/16	8611	6611
31/32	8612	6612
1"	8613	6613
1-1/32	8614	6614
1-1/16	8615	6615
1-3/32	8616	6616
1-1/8	8617	6617
1-5/32	8618	6618
1-3/16	8619	6619
1-7/32	8620	6620
1-1/4	8621	6621
1-9/32	8622	6622





L 150 SERIES SQUARE - RECTANGULAR

UNI-HYDRO PUNCHES & DIES

L 150 Square

SIZE	PUNCH	DIE
8651	5/8	6651
8652	21/32	6652
8653	11/16	6653
8654	23/32	6654
8655	3/4	6655
8656	25/32	6656
8657	13/16	6657
8658	27/32	6658
8659	7/8	6659
8660	29/32	6660
8661	15/16	6661
8662	31/32	6662
8663	1"	6663
8664	1-1/32	6664

L 150 Rectangular

SIZE	PUNCH	DIE
8701	3/4 X 5/8	6701
8702	3/4 X 21/32	6702
8703	3/4 X 11/16	6703
8704	3/4 X 23/32	6704
8705	1 X 5/8	6705
8706	1 X 21/32	6706
8707	1 X 11/16	6707
8708	1 X 23/32	6708
8709	1 X 3/4	6709
8710	1 X 25/32	6710
8711	1 X 13/16	6711
8712	1 X 27/32	6712
8713	1 X 7/8	6713
8714	1 X 29/32	6714
8715	1 X 15/16	6715
8716	1 X 31/32	6716
8717	1-1/4 X 5/8	6717
8718	1-1/4 X 21/32	6718
8719	1-1/4 X 11/16	6719
8720	1-1/4 X 23/32	6720
8721	1-1/4 X 3/4	6721
8722	1-1/4 X 25/32	6722
8723	1-1/4 X 13/16	6723
8724	1-1/4 X 27/32	6724
8725	1-1/4 X 7/8	6725
8726	1-1/4 X 29/32	6726
8727	1-1/4 X 15/16	6727
8728	1-1/4 X 31/32	6728
8729	1-1/4 X 1"	6729
8730	1-1/4 X 1-1/32	6730
8731	1-1/4 X 1-1/16	6731
8732	1-1/4 X 1-3/32	6732
8733	1-1/4 X 1-1/8	6733
8734	1-1/4 X 1-5/32	6734
8735	1-1/4 X 1-3/16	6735
8736	1-1/4 X 1-7/32	6736





L 150 SERIES OVAL

UNI-HYDRO PUNCHES & DIES

L 150 Oval

SIZE	PUNCH	DIE
8751	1 X 7/16	6751
8752	1 X 15/32	6752
8753	1 X 1/2	6753
8754	1 X 17/32	6754
8755	1 X 9/16	6755
8756	1 X 19/32	6756
8757	1 X 5/8	6757
8758	1 X 21/32	6758
8759	1 X 11/16	6759
8760	1 X 23/32	6760
8761	1 X 3/4	6761
8762	1 X 25/32	6762
8763	1 X 13/16	6763
8764	1 X 27/32	6764
8765	1 X 7/8	6765
8766	1 X 29/32	6766
8767	1 X 15/16	6767
8768	1 X 31/32	6768
8769	1-1/4 X 7/16	6769
8770	1-1/4 X 15/32	6770
8771	1-1/4 X 1/2	6771
8772	1-1/4 X 17/32	6772
8773	1-1/4 X 9/16	6773
8774	1-1/4 X 19/32	6774
8775	1-1/4 X 5/8	6775
8776	1-1/4 X 21/32	6776
8777	1-1/4 X 11/16	6777
8778	1-1/4 X 23/32	6778
8779	1-1/4 X 3/4	6779
8780	1-1/4 X 25/32	6780
8781	1-1/4 X 13/16	6781
8782	1-1/4 X 27/32	6782
8783	1-1/4 X 7/8	6783
8784	1-1/4 X 29/32	6784
8785	1-1/4 X 15/16	6785

L 150 Oval

SIZE	PUNCH	DIE
8786	1-1/4 X 31/32	6786
8787	1-1/4 X 1	6787
8788	1-1/4 X 1-1/32	6788
8789	1-1/4 X 1-1/16	6789
8790	1-1/4 X 1-3/32	6790
8791	1-3/8 X 7/16	6791
8792	1-3/8 X 15/32	6792
8793	1-3/8 X 1/2	6793
8794	1-3/8 X 17/32	6794
8795	1-3/8 X 9/16	6795
8796	1-3/8 X 19/32	6796
8797	1-3/8 X 5/8	6797
8798	1-3/8 X 21/32	6798
8799	1-3/8 X 11/16	6799
8800	1-3/8 X 23/32	6800
8801	1-3/8 X 3/4	6801
8802	1-3/8 X 25/32	6802
8803	1-3/8 X 13/16	6803
8804	1-3/8 X 27/32	6804
8805	1-3/8 X 7/8	6805
8806	1-3/8 X 29/32	6806
8807	1-3/8 X 15/16	6807
8808	1-3/8 X 31/32	6808
8809	1-3/8 X 1"	6809
8810	1-3/8 X 1-1/32	6810
8811	1-3/8 X 1-1/16	6811
8812	1-3/8 X 1-3/32	6812
8813	1-3/8 X 1-1/8	6813
8814	1-3/8 X 1-5/32	6814
8815	1-3/8 X 1-3/16	6815
8816	1-3/8 X 1-7/32	6816
8817	1-3/8 X 1-1/4	6817
8818	1-3/8 X 1-9/32	6818
8819	1-3/8 X 1-5/16	6819

L 150 Oval

SIZE	PUNCH	DIE
8820	1-3/8 X 1-11/32	6820
8821	1-1/2 X 7/16	6821
8822	1-1/2 X 15/32	6822
8823	1-1/2 X 1/2	6823
8824	1-1/2 X 17/32	6824
8825	1-1/2 X 9/16	6825
8826	1-1/2 X 19/32	6826
8827	1-1/2 X 5/8	6827
8828	1-1/2 X 21/32	6828
8829	1-1/2 X 11/16	6829
8830	1-1/2 X 23/32	6830
8831	1-1/2 X 3/4	6831
8832	1-1/2 X 25/32	6832
8833	1-1/2 X 13/16	6833
8834	1-1/2 X 27/32	6834
8835	1-1/2 X 7/8	6835
8836	1-1/2 X 29/32	6836
8837	1-1/2 X 15/16	6837
8838	1-1/2 X 31/32	6838
8839	1-1/2 X 1"	6839
8840	1-1/2 X 1-1/32	6840
8841	1-1/2 X 1-1/16	6841
8842	1-1/2 X 1-3/32	6842
8843	1-1/2 X 1-1/8	6843
8844	1-1/2 X 1-5/32	6844
8845	1-1/2 X 1-3/16	6845
8846	1-1/2 X 1-7/32	6846
8847	1-1/2 X 1-1/4	6847
8848	1-1/2 X 1-9/32	6848
8849	1-1/2 X 1-5/16	6849
8850	1-1/2 X 1-11/32	6850
8851	1-1/2 X 1-3/8	6851
8852	1-1/2 X 1-13/32	6852
8853	1-1/2 X 1-7/16	6853
8854	1-1/2 X 1-15/32	6854





500 SERIES PUNCHES & DIES

UNI-HYDRO PUNCHES & DIES

The 500 Series round punches have 2 1/2" shanks for superb strength and durability when punching very large holes.

Models: 80-24, PRO-80-24, PRO 105-24, PRO 125-24, PRO 135-24, PRO 150-24



PUNCH	SIZE	DIE
9000	1-1/2"	7000
9001	1-9/16"	7001
9002	1-5/8"	7002
9003	1-11/16"	7003
9004	1-3/4"	7004
9005	1-13/16"	7005
9006	1-7/8"	7006
9007	1-15/16"	7007
9008	2"	7008
9009	2-1/16"	7009
9010	2-1/8"	7010
9011	2-3/16"	7011
9012	2-1/4"	7012





S-SERIES PUNCHES & DIES

UNI-HYDRO PUNCHES & DIES



Used when punching close to the edge on angle iron.

DIES	ROUND
6001	1/8
6002	9/64
6003	5/32
6004	11/64
6005	3/16
6006	13/64
6007	7/32
6008	15/64
6009	1/4
6010	17/64
6011	9/32
6012	19/64
6013	5/16
6014	21/64
6015	11/32
6016	23/64
6017	3/8
6018	25/64
6019	13/32
6020	27/64
6021	7/16
6022	29/64
6023	15/32
6024	31/64
6025	1/2
6026	33/64
6027	17/32
6028	35/64
6029	9/16
6030	37/64
6031	19/32
6032	39/64
6033	5/8
6034	41/64
6035	21/32
6036	43/64
6037	11/16
6038	45/64
6039	23/32
6040	47/64
6041	3/4
6042	49/64
6043	25/32
6044	51/64
6045	13/16

DIES	OVAL
6051	1/2 X 1/8
6052	1/2 X 5/32
6053	1/2 X 3/16
6054	1/2 X 7/32
6055	1/2 X 1/4
6056	1/2 X 9/32
6057	1/2 X 5/16
6058	1/2 X 11/32
6059	1/2 X 3/8
6060	1/2 X 13/32
6061	1/2 X 7/16
6062	1/2 X 15/32
6063	3/4 X 1/8
6064	3/4 X 5/32
6065	3/4 X 3/16
6066	3/4 X 7/32
6067	3/4 X 1/4
6068	3/4 X 9/32
6069	3/4 X 5/16
6070	3/4 X 11/32
6071	3/4 X 3/8
6072	3/4 X 13/32
6073	3/4 X 7/16
6074	3/4 X 15/32
6075	3/4 X 1/2
6076	3/4 X 17/32
6077	3/4 X 9/16
6078	3/4 X 19/32
6079	3/4 X 5/8
6080	3/4 X 21/32
6081	3/4 X 11/16
6082	3/4 X 23/32





There are several unique punches and dies used in the industry that are the next most frequent request after our stock series. These are lattice, corner, picket fence and keyhole. These four series are manufactured in the same manner as our other series coated with oil to prevent rust. We also manufacture a unique series of plates and encourage users to contact us with any special request.



Keyhole Punches & Dies

Punches a keyhole into bar stock up to 1/4 inch thickness. Found on farm equipment, a chain is inserted through a keyhole and is dropped into it securing the chain in position.



Corner Radius Punches & Dies

Rounds the edge on bar stock. Place bar stock into die and punch. Bar stock has a nicely rounded end.



Picket Fence Punches & Dies

Used to press the end of tubular square or round together into a point. This is used for steel fence posts or small signs.



Lattice Punches & Dies

Used to round the ends of bar stock up to 1/4 inch thick. Place bar stock into channel in die and punch. Clips a small piece out of a bar leaving two rounded edges, one on each remaining bar.

CALL OUR SALES TEAM AT (800) 328-0038 FOR SPECIAL ORDERS





Uni-Hydro manufactures Punches, Dies and other accessories to facilitate our customer's growing interests in metal fabrication. Over the years we have made hundreds of special configurations in punches, dies, sever and slug style plates.

We have built an array of tools used in our ironworkers that clients have asked for specifically to their configurations. We are here to help with all you needs.

Screw On Punches

There have been a few occasions where we've made a special "screw on punch", which screws on the punch ram threads directly and doesn't use a punch retaining nut. An example of this application would be for an oval shape that would allow the oval to be punched in a vertical or horizontal direction. This is accomplished by inserting a spacer (or shim) before you screw on this style of punch, the extra thickness makes the slot now face vertically instead of horizontally when facing the punch station.

CALL OUR SALES TEAM AT (800) 328-0038 FOR SPECIAL ORDERS



Outfit your Ironworker for maximum productivity with these exceptional tooling choices, optimized for the Power Cavity, Punch and Notching Stations.



SLUG TYPE ANGLE SHEAR



UNIVERSAL SEVER HOUSING FRONT



UNIVERSAL SEVER HOUSING BACK



UNIVERSAL SEVER HOUSING



SPEING RETURN BRAKE



2-PART BRAKE



PIPE NOTCHER



SQUARE NOTCHER



V-COPER NOTCHER



CHANNEL SEVER PLATE

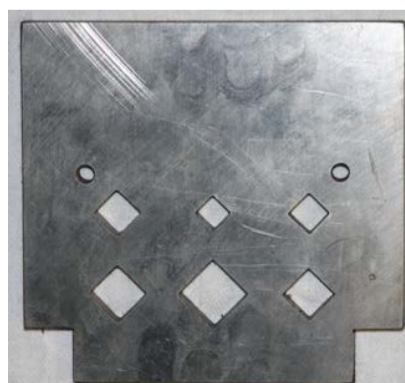

ROD SEVER PLATE

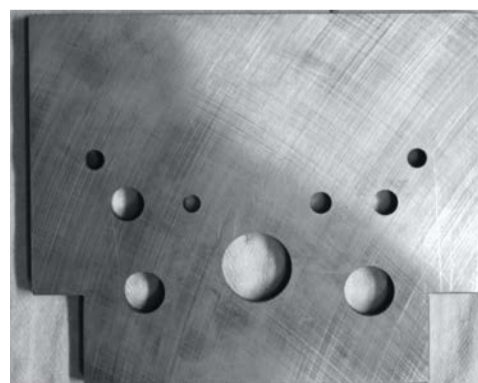

BAR SEVER PLATE

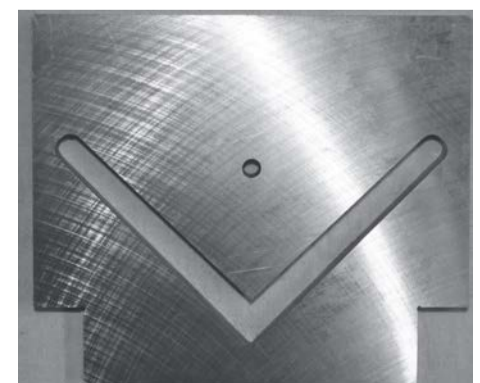

ANGLE SEVER PLATE



UNIVERSAL SEVER HOUSING

UNI-HYDRO TOOLING CATALOG



Model	Part #
IE 30	2606
T40	2612
45-14	2612
IE 55	5516
56-14	2615
80-24	2623
PRO 56	2615
PRO 80	2623
PRO 105	2623
PRO 125	2625
135 PRO	2628
150 PRO	2628

The **Universal Sever Housing** is a spring return tool inside of the power cavity, that allows different blades to be set into the housing to perform their job. Various blades are available for cutting different sizes and types of stock such as Angle, Channel, Rod and Z & T. **See next two pages for blade images.**

Models	Blades
Standard Series & Turret	Angle, Rod, Channel * Specify weight of channel when ordering blades
PRO Series	Angle, Rod, Channel * Specify weight of channel when ordering blades





STANDARD & TURRET BLADES

UNI-HYDRO TOOLING CATALOG



CHANNEL SEVER PLATE

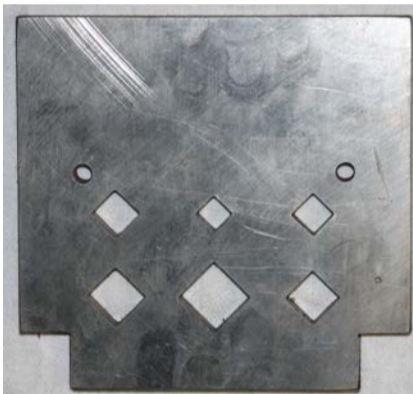

ROD SEVER PLATE



BAR SEVER PLATE

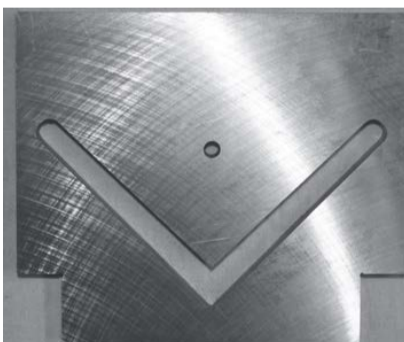

ANGLE SEVER PLATE

Model	Part #	Description * Specify weight of channel when ordering channel blades
IE 30	1922	Angle Shear Blade 3" X 3" X 1/4"
	1818	Rod Shear Blade 4 Hole
	1819	Channel Shear Blade 1" *
	1820	Channel Shear Blade 2" (2.32 lbs) *
T40	3338	Angle Shear Blade 3" X 3" X 1/4"
	3339	Rod Shear Blade 6 Hole 3/8, 7/16, 1/2, 9/16, 5/8, 3/4
	4431	2" Channel Shear Blade Set *
	4430	3" Channel Shear Blade Set *
45-14	3338	Angle Shear Blade 3" X 3" X 1/4"
	3339	Rod Shear Blade 6 Hole 3/8, 7/16, 1/2, 9/16, 5/8, 3/4
	4431	2" Channel Shear Blade Set *
	4430	3" Channel Shear Blade Set *
IE 55	2756	Rod Shear Blade 7 Hole 1/4, 5/16, 3/8, 1/2, 9/16, 5/8, 3/4, 1-1/16
	4431	2" Channel Shear Blade Set *
	4430	3" Channel Shear Blade Set *
	56-14	2730
2756		Rod Shear Blade 7 Hole 1/4, 5/16, 3/8, 1/2, 9/16, 5/8, 3/4, 1-1/16
4431		2" & 3" Channel Shear Blade Set *
4432		4" Channel Shear Blade Set *
80-24	3580	Angle Shear Blade 4" X 4" X 3/8"
	3579	Rod Shear Blade 10 Hole 1/4, 5/16, 3/8, 7/16, 1/2, 5/8, 3/4, 7/8, 1, 1-1/16
	4435	2" & 3" Channel Shear Blade Set *
	4436	4" Channel Shear Blade Set *
	4437	5" Channel Shear Blade Set *
	4438	6" Channel Shear Blade Set *





CHANNEL SEVER PLATE

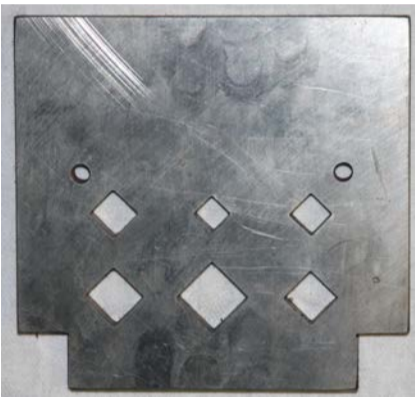

ROD SEVER PLATE

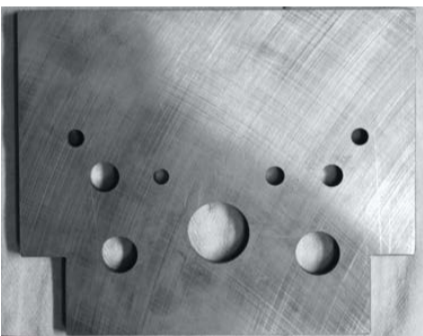

BAR SEVER PLATE

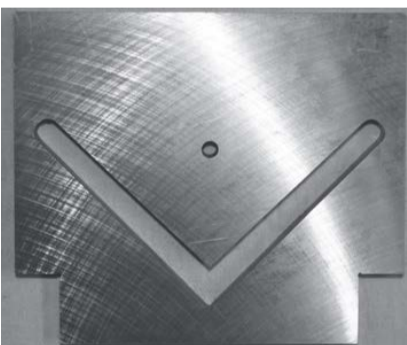

ANGLE SEVER PLATE

Model	Part #	Description
* Specify weight of channel when ordering channel blades		
PRO 56	2730	Angle Shear Blade 4" X 4" X 3/8"
	2756	Rod Shear Blade 7 Hole 1/4, 5/16, 3/8, 1/2, 9/16, 5/8, 3/4, 1-1/16
	4431	2" & 3" Channel Shear Blade Set *
	4432	4" Channel Shear Blade Set *
PRO 80	3580	Angle Shear Blade 4" X 4" X 3/8"
	3579	Rod Shear Blade 10 Hole
		1/4, 5/16, 3/8, 7/16, 1/2, 5/8, 3/4, 7/8, 1, 1-1/16
	4435	2" & 3" Channel Shear Blade Set *
	4436	4" Channel Shear Blade Set *
	4437	5" Channel Shear Blade Set *
PRO 105	3580	Angle Shear Blade 4" X 4" X 3/8"
	3579	Rod Shear Blade 10 Hole
		1/4, 5/16, 3/8, 7/16, 1/2, 5/8, 3/4, 7/8, 1, 1-1/16
	4439	2" & 3" Channel Shear Blade Set *
	4440	4" Channel Shear Blade Set *
	4441	5" Channel Shear Blade Set *
	4442	6" Channel Shear Blade Set *
PRO 125	3326	Angle Shear Blade 6" X 6" X 3/8"
	3327	Rod Shear Blade 10 Hole
		1/4, 5/16, 3/8, 7/16, 1/2, 5/8, 3/4, 7/8, 1, 1-1/16
	4439	2" & 3" Channel Shear Blade Set *
	4440	4" Channel Shear Blade Set *
	4441	5" Channel Shear Blade Set *
135 PRO	2740	Angle Shear Blade 6" X 6" X 3/8"
	2742	Rod Shear Blade 10 Hole
		1/4, 5/16, 3/8, 7/16, 1/2, 5/8, 3/4, 7/8, 1, 1-1/4
	4433	2" & 3" Channel Shear Blade Set *
	4444	4" Channel Shear Blade Set *
	4445	5" Channel Shear Blade Set *
	4446	6" Channel Shear Blade Set *
	4447	7" Channel Shear Blade Set *
	4448	8" Channel Shear Blade Set *
150 PRO	2740	Angle Shear Blade 6" X 6" X 3/8"
	2742	Rod Shear Blade 10 Hole
		1/4, 5/16, 3/8, 7/16, 1/2, 5/8, 3/4, 7/8, 1, 1-1/4
	4433	2" & 3" Channel Shear Blade Set *
	4444	4" Channel Shear Blade Set *
	4445	5" Channel Shear Blade Set *
	4446	6" Channel Shear Blade Set *
	4447	7" Channel Shear Blade Set *
	4448	8" Channel Shear Blade Set *





SLUG TYPE ANGLE SHEAR

UNI-HYDRO TOOLING CATALOG



A Slug Type Angle Shear makes two cuts at the same time discharging a slug from between the cuts. A second blade is used to hold the metal stationary which produces a very clean cut on angle stock.

Model	Part #	Description
30-8	N/A	-----
T40	4406	3 X 3 X 3/8
45-14	4406	3 X 3 X 3/8
IE 55	N/A	-----
56-14	4406	3 X 3 X 3/8
80-24	2574	6 X 6 X 1/2
PRO 56	4406	3 X 3 X 3/8
PRO 80	2574	6 X 6 X 1/2
PRO 105	2576	6 X 6 X 1/2
PRO 125	2576	6 X 6 X 1/2
135 PRO	2577	6 X 6 X 1/2
150 PRO	2577	6 X 6 X 1/2





2-PART BRAKE

UNI-HYDRO TOOLING CATALOG



Model	6" - Punch Station	6" - Power Cavity	9" - Punch Station	9" - Power Cavity	14" - Power Cavity
IE 30	2595	2590	---	---	---
T40	---	2497	---	2496	---
45-14	3212	2591	---	2592	---
IE 55	3212	---	10" - 5685	---	---
56-14	3212	2591	---	2592	---
80-24	3565	3434	3566	3452	3488
PRO 56	3212	2580	---	2568	---
PRO 80	3565	3434	3566	3452	3488
PRO 105	3565	3434	3566	3452	3488
PRO 125	3565	3434	3566	3452	3488
135 PRO	3309	3782	3310	2589	3783
150 PRO	3309	3782	3310	2589	3783





SPRING RETURN BRAKE

UNI-HYDRO TOOLING CATALOG



Model	18" - Punch Station	24" - Punch Station
IE 30	---	---
T40	---	---
45-14	---	---
IE 55	---	---
56-14	---	---
80-24	3306	3308
PRO 56	---	---
PRO 80	3306	3308
PRO 105	3306	3308
PRO 125	3306	3308
135 PRO	3306	3308
150 PRO	3306	3308





If you are cutting angle iron to form a corner, bend or new angle, a coper notcher is the correct tool.

Model	Part #	Description
IE 30	2579	3 x 3 x 1/4 Angle
T40	3718	3 x 3 x 1/4 Angle
45-14	1277	3 x 3 x 1/4 Angle
IE 55	1277	3 x 3 x 1/4 Angle
56-14	1277	3 x 3 x 1/4 Angle
80-24	3317	4 x 4 x 1/2 Angle
PRO 56	1277	3 x 3 x 1/4 Angle
PRO 80	3317	4 x 4 x 1/2 Angle
PRO 105	3317	4 x 4 x 1/2 Angle
Notch, Angle or Punch Station	1277	3 x 3 x 1/4 Angle
PRO 125	3317	4 x 4 x 1/2 Angle
Notch, Angle or Punch Station	1277	3 x 3 x 1/4 Angle
135 PRO	3318	4 x 4 x 1/2 Angle
150 PRO	3318	4 x 4 x 1/2 Angle



SQUARE NOTCHER

UNI-HYDRO TOOLING CATALOG



To take a complete corner out of stock, forming something new or just need to nibble, opt for a square notcher

Model	Part #	Description
IE 30		
T40	3717	1 3/4 x 2 x 1/4
45-14	1276	1 3/4 x 2 x 1/4
IE 55	1276	1 3/4 x 2 x 1/4
56-14	1276	1 3/4 x 2 x 1/4
80-24	3315	3 x 3 x 3/8
PRO 56	1276	1 3/4 x 2 x 1/4
PRO 80	3315	3 x 3 x 3/8
PRO 105	3315	3 x 3 x 3/8
Notcher Station Only	3737	2 x 3 x 3/8
PRO 125	3315	3 x 3 x 3/8
Notcher Station Only	3737	2 x 3 x 3/8
135 PRO	3316 B	3 x 3 x 3/8
Notcher Station Only	3316 A	3 x 3 x 5/16
150 PRO	3316 B	3 x 3 x 3/8
Notcher Station Only	3316 A	3 x 3 x 5/16



HOUSINGS

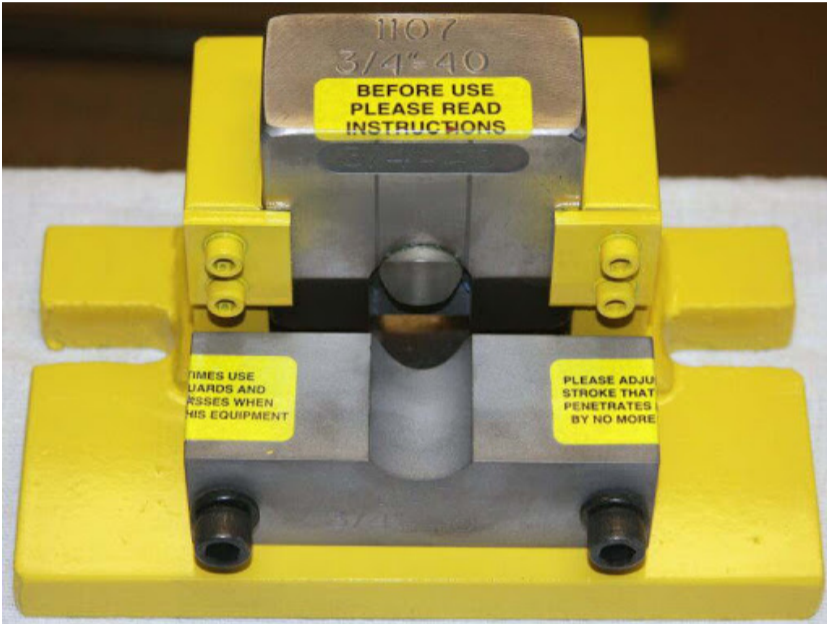

Model	Housing #
IE 30	3081
T40	3094
45, IE 55, 56, Pro 56	3080
80, Pro 80	3095
Pro 105, Pro 125	3095
135 PRO, 150 PRO	3073

DIE SETS



Pipe Die Size Sets	Schedule 40	Schedule 80
1/2" Pipe	3082	3083
3/4" Pipe	3084	3085
1" Pipe	3086	3087
1-1/4" Pipe	3088	3089
1-1/2" Pipe	3090	3091
2" Pipe	3092	3093



ACCESSORIES

OPTIMIZED FOR PRODUCTIVITY



PUNCH TABLE WITH ADJUSTABLE JIG



BAR SHEAR TABLE



STEEL BIN CATCHER



PUNCH & DIE RACK



PUNCH NUT WRENCHES



OVERSIZE DIE STANDS



DELUXE BACK GAUGE

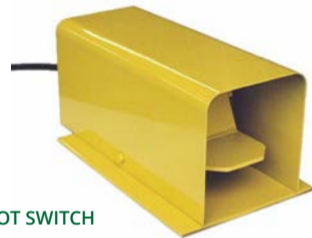

REMOTE FOOT SWITCH

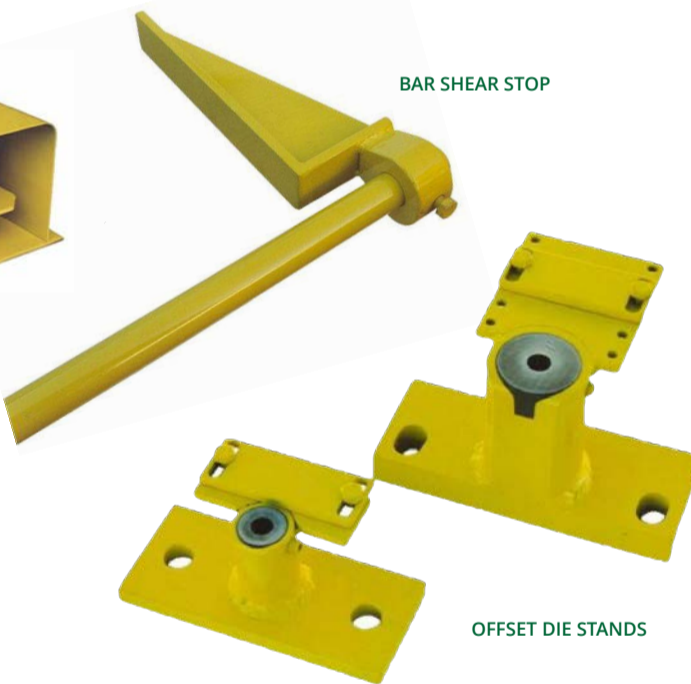

BAR SHEAR STOP

OFFSET DIE STANDS

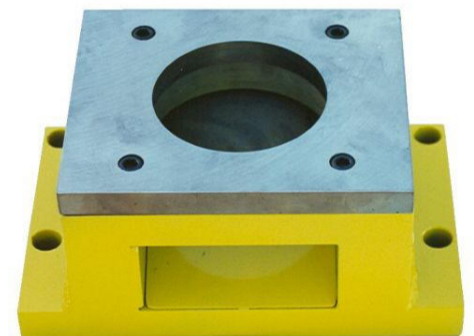

SPECIAL DIE STAND WITH 7x7 PLATE DIE

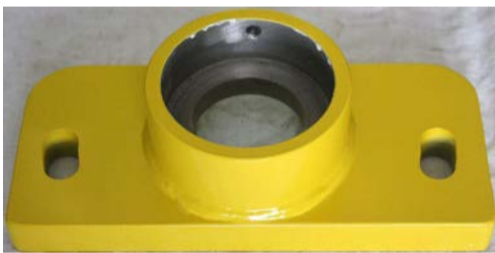

OVERSIZE DIE STAND



OVERSIZE DIE SETS



GREASE BANK



OFFSET DIE STANDS





IRONWORKER

PUNCH TONNAGE CHART

HOLE DIAMETER	3/16"	5/16"	7/16"	1/2"	9/16"	5/8"	11/16"	3/4"	13/16"	7/8"	15/16"	1"	1-1/8"	1-1/4"	1-1/2"
THICKNESS	PRESSURE IN TONS														
18 GA	0.5	0.7	1.6	1.9	2.1	2.4	2.6	2.8	3.1	3.3	3.5	3.8	4	4.2	5.6
16 GA	0.6	0.9	2.1	2.3	2.6	2.9	3.2	3.5	3.8	4.1	4.4	4.7	4.8	6	7
14 GA	0.7	1.2	2.6	2.9	3.3	3.7	4	4.4	4.8	5.1	5.5	5.9	5	7.2	10
12 GA	1	1.5	3.6	4.1	4.6	5.1	5.7	6.2	6.7	7.2	7.7	8.2	7	10	12
10 GA	1.3	2	4.6	5.3	5.9	6.6	7.3	7.9	8.6	9.2	9.9	10.6	10	13	15
5/32"	-	2.3	5.4	6.1	6.9	7.7	8.4	9.2	10	10.7	11.5	12.3	11	16	19
3/16"	-	2.8	6.4	7.4	8.3	9.2	10.1	11	12	12.9	13.8	14.8	17	19	23
1/4"	-	-	8.6	9.8	11.1	12.3	13.5	14.7	16	17.2	18.4	19.7	23	25	30
3/8"	-	-	12.8	14.8	16.5	18.5	20.2	22.1	23.8	25.8	27.5	29.5	33	38	45
1/2"	-	-	-	19.7	22	24.6	26.9	29.5	31.8	34.4	36.8	39.4	45	50	60
5/8"	-	-	-	-	-	30.8	33.7	36.9	39.9	43	46	49.2	56	63	75
3/4"	-	-	-	-	-	-	-	44.3	47.7	51.7	55.2	59	68	75	90
1"	-	-	-	-	-	-	-	-	-	-	-	80	90	100	120

OVER 20,000 PUNCH & DIE SETS IN STOCK!

CALL TODAY!

UNI-HYDRO INC. - 310 EAST GEMINI AVE. COSMOS, MN 56228. USA

(800) 328-0036



UNI-HYDRO™

BUILT IN COSMOS, MN 

FOR MORE INFORMATION VISIT

WWW.UNIHYDRO.COM

(800) 328-0036

